

# Saving the best for last

## Softstarters or variable-speed drives, or both?

JUAN SAGARDUY, JESPER KRISTENSSON, SÖREN KLING, JOHAN REES – In water applications, centrifugal pumps are driven by an induction motor directly fed from the network. Flow regulation is accomplished by a few different means, namely throttling, a highly inefficient method as hydraulic losses increase dramatically when the flow is strangled by a valve; variable-frequency drives (VFD), recommended as an effective means of saving energy, ensure flow regulation by controlling the rotational speed of the motor shaft; and alternatively, on and off pump operation following a precise duty cycle – the pump is not operated continuously, but switched on for the time needed for pumping the target water volume and disconnected for the rest of the time. Given that many different hydraulic systems recommend the use of frequency converters or cyclic control (ie, softstarter technologies), which one of these two solutions is the most cost-effective in reducing energy consumption and providing the most satisfactory payback time?

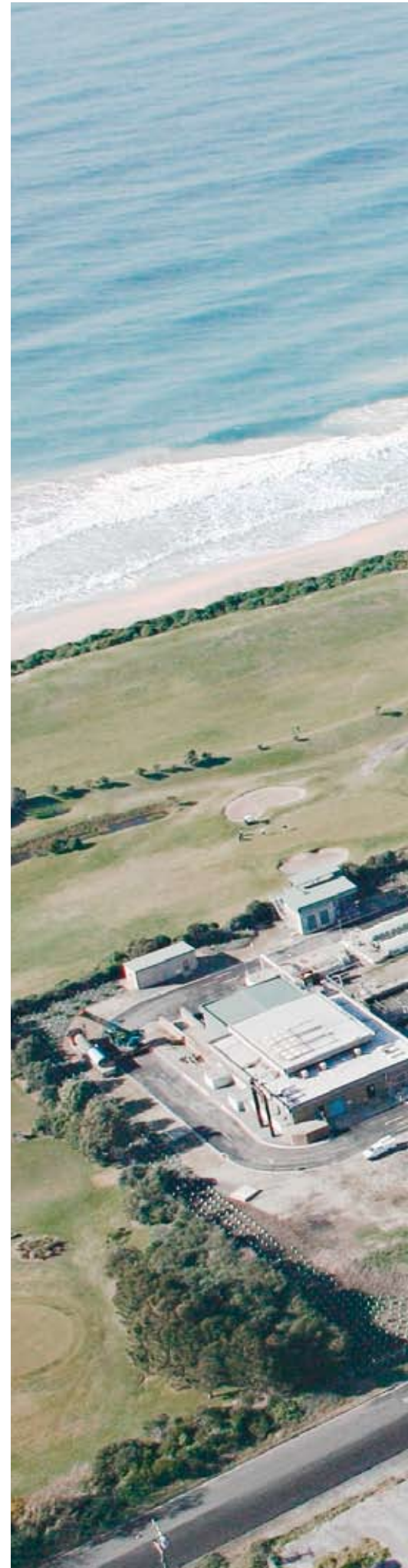



## Nomenclature

$H_{bep}$ [m]:	Hydraulic head at the best efficiency point of the centrifugal pump
$Q_{bep}$ [m <sup>3</sup> /s]:	Capacity at the best efficiency point of the pump
$H_{st}$ [m]:	Total static head. This is defined as the vertical distance the pump must lift the water. When pumping from a well, it would be the distance from the pumping water level in the well to the ground surface plus the vertical distance the water is lifted from the ground surface to the discharge point. When pumping from an open water surface it would be the total vertical distance from the water surface to the discharge point.
$Q_{op}$ [m <sup>3</sup> /s]:	Capacity at the system design point. In practice, this is determined for peak flows arising occasionally (ie, around 5 percent of the time in water treatment plants).
$H_{op}$ [m]:	Hydraulic head at system design point.
$H_{op,id}$ [m]:	Hydraulic head at the design point in an ideal system.
$H_t$ [m]:	Hydraulic head associated with a generic capacity $Q$ [m <sup>3</sup> /s] in fixed speed and throttled flow regulation
$H_d$ [m]:	Hydraulic head associated with a generic capacity $Q$ [m <sup>3</sup> /s] in variable frequency flow regulation
$H_{max}$ [m]:	Maximum height at which liquid can be lifted by a given pump
$Q_{max}$ [m <sup>3</sup> /s]:	Maximum capacity for a given pump

## 1 System illustration for throttled, cyclic and VFD flow control methods

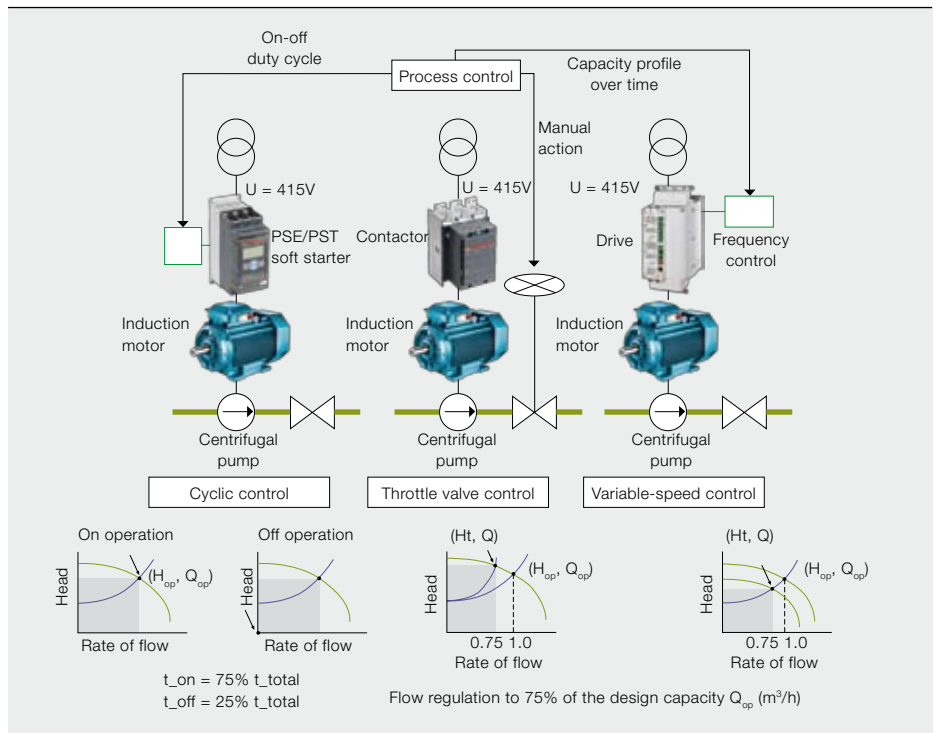

Energy efficiency is a very important aspect that customers seek in products and systems and something that suppliers work hard at improving in their product offering. In fact, the general view held is that the investment linked to the purchase of electrical equipment, as well as the downtime cost incurred from installation and commissioning is offset by a decrease in electricity consumption due to energy efficient operation.

ABB's commitment to energy efficiency is unquestionable and the company has devoted time, know-how and resources in order to offer market-leading low-voltage solutions – in the form of frequency converters and softstarters<sup>1</sup> – which are especially suitable for maximizing energy savings in water pump and waste applications.

As throttling is highly inefficient, which one of the two technical solutions, variable-speed or cyclic control, is the most cost-effective in reducing energy con-

sumption → 1? In fact, the nature of the hydraulic system in which the centrifugal pump operates is the determining factor in selecting one or the other control method.

In wastewater processing for example, the on/off operation of the centrifugal pumps is, in general, process based. Residual water (ie, effluent from residential or commercial buildings) is commonly collected in septic tanks or sewage basins until it is pumped to municipal treatment plants [1]. Owing to several start events, the use of softstarters significantly reduces the risk of pump clogging due to sludge in the water → 2. In general cyclic control is an attractive

## 2 ABB's PSE compact softstarter range is used primarily for pumping applications



### Footnote

<sup>1</sup> By reducing the applied voltage, a softstarter allows smooth starting of AC motors. During pump stop, water hammer in the hydraulic system is avoided by a controlled decrease in torque enabled by a dedicated algorithm in the softstarter.

### 3a Pump selection for an industrial installation

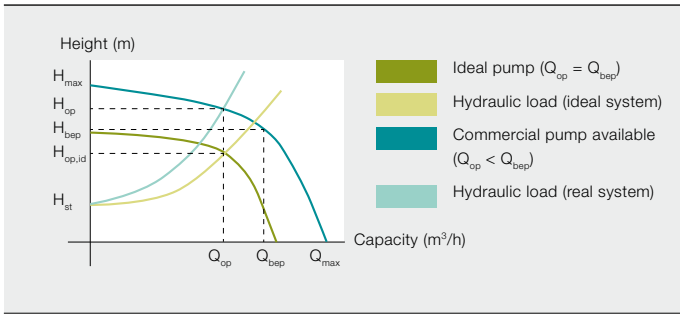

### 4 Characteristic data of the two pumps studied

Manufacturer	Power (kW)	$H_{max}$ (m)	$H_{bep}$ (m)	$Q_{bep}$ (m³/h)	$\eta_{max}$ (%)
Aurora	90	43.6	27.6	575	74.8
Aurora	350	52.7	33.8	2,500	84.5

### 5 The hydraulic systems selected for energy saving potential analysis

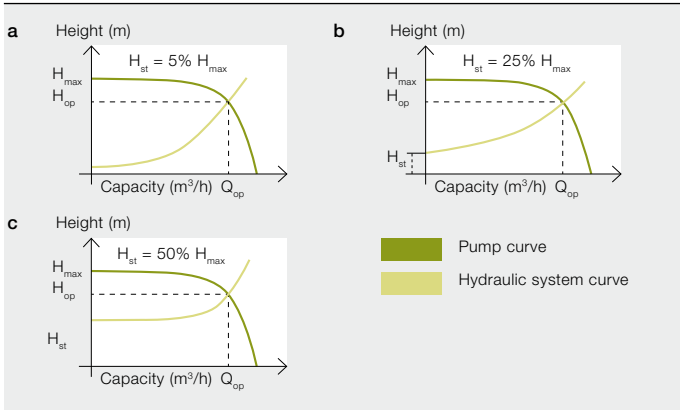

- a Friction head dominated
- b Mixed head dominated
- c Static head dominated

alternative to the variable-frequency drive (VFD) strategy despite it losing flexibility in flow regulation. In other words, a softstarter is seen as a suitable and competitive technology which preserves the induction motor from electrical strain, mechanical shock and vibration during start up and prevents water hammering as the pump stops. Additionally, the motor is used at its best efficiency point and switched off the rest of the time.

In the following sections, energy savings and payback of variable-speed and cyclic control solutions are analyzed for two centrifugal pump systems (90 kW and 350 kW).

#### A typical pump system

When a pump system is assembled, a target flow  $Q_{op}$  [m³/h] must be guaranteed. In an ideal system, the selected

pump has a coincident  $Q_{bep}$  [m³/h] with  $Q_{op}$  [m³/h]. In reality, however, a larger pump is chosen → 3a. As a result, the pump works under reduced hydraulic efficiency for most of the capacity range. This point is illustrated in → 3b for two Aurora centrifugal pumps with power ratings of 90 kW and 350 kW respectively → 4 [2].

To analyze the potential for energy savings in these pumps three different hydraulic systems were taken into account: friction head dominated, ie, the ratio ( $\nu$ ) of static head  $H_{st}$  [m] to maximum hydraulic height  $H_{max}$  [m] is 5 percent; static head dominated ( $\nu$  is 50 percent); and mixed ( $\nu$  is 25 percent) → 5.

#### Converter, softstarter and motor performance

Frequency converters have a high efficiency ( $\eta_{conv}$ ), which drops naturally

### 3b Hydraulic efficiency drop in 90kW and 350kW pumps due to 15% oversizing

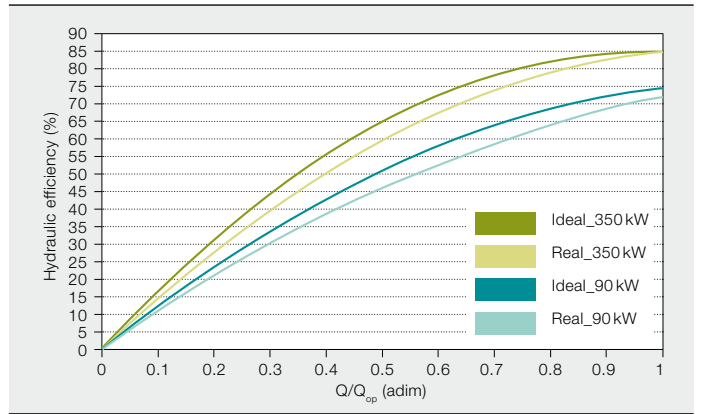

### 6 Variation of electrical efficiency (%) in the power electronics circuit (softstarter and converter) with hydraulic load



ABB has devoted time, know-how and resources in order to offer market-leading low-voltage solutions that are especially suitable for maximizing energy savings in water pump and waste applications.

## 7a Impact of class type on motor efficiency



## 7b Variation of motor efficiency with hydraulic load

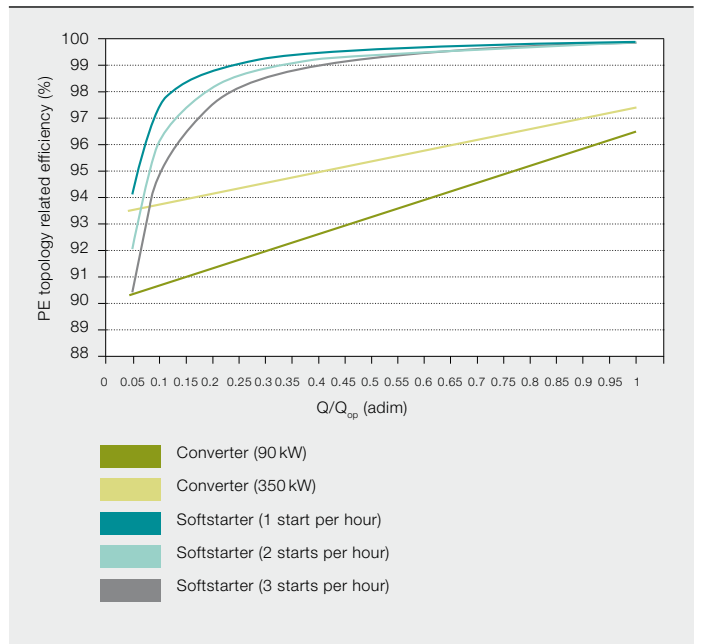
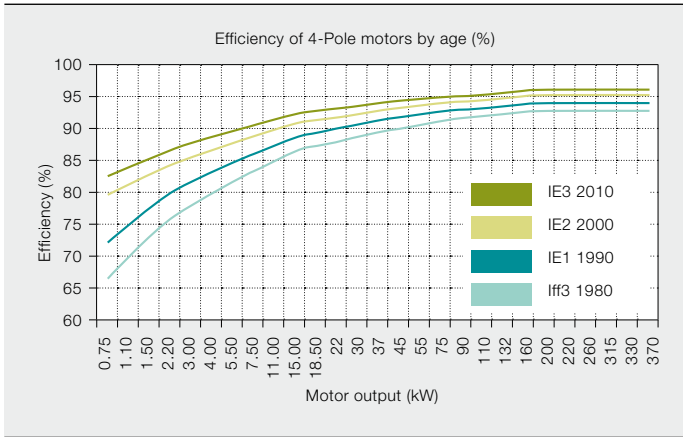
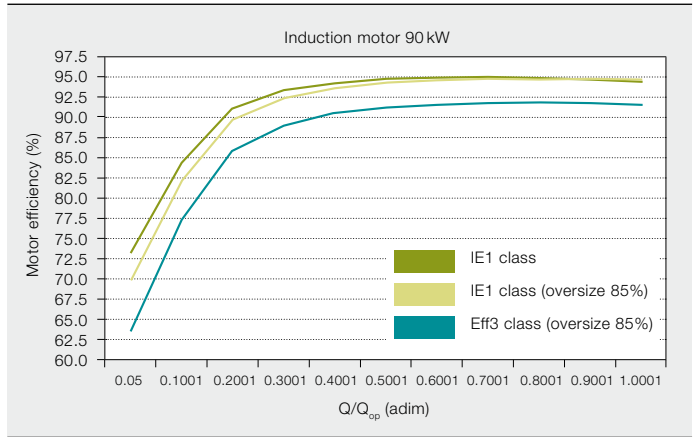

## 8 Effect of system oversizing, motor class and harmonic losses on electric power consumption (Pn =90 kW – switching frequency 4 kHz)

Efficiency drop (%) caused by	Load (%)				
	5%	25%	50%	75%	100%
1 – Oversized pump (by 15%)	-1.3	-3.8	-6.0	-4.5	-2.1
2 – Oversized motor (by 15%)	-3.2	-1.2	-0.4	-3.0	0.2
3 – Motor class (Eff 3)	-9.5	-3.4	-3.0	-3.0	-3.0
4 – Harmonic loss	-7.0	-2.1	-2.4	-1.9	-1.3
Increase in power consumption (%)	26.5	11.7	13.3	10.3	6.6

when the output power decreases with respect to the rated value. The efficiency of softstarters is practically 100 percent when the motor bypass is activated. Their efficiency decreases noticeably with the number of starts per hour and shorter operating time intervals owing to additional joule losses during motor start and stop → 6.

Tighter standards (IEC classes) nowadays guarantee high motor efficiency – in general greater than 90 percent – for loads [3, 4] → 7a and → 7b. This efficiency (strongly dependent on its graded class) is affected by the use of either a frequency converter or softstarter: it decreases when supplied by a fast switching converter due to harmonic current and voltage distortion but is not altered when the motor is bypassed after softstarting due to a purely sinusoidal supply.

The impact of system oversizing, motor class and harmonic losses (drive control) in a real system is given in → 8.

### Energy savings

Energy savings made using VFD and cyclic control in a 90 kW and 350 kW pump system are illustrated in → 9a and → 9b respectively. In friction head domi-

nated systems ( $v = 5$  percent), VFD control ensures higher energy savings across almost the entire operating range (ie, 7 to 98 percent) in both pump systems. In a 90 kW pump and static head dominated system ( $v = 50$  percent), cyclic control is a better technical solution than VFD con-

The total initial investment associated with VFD and cyclic solutions is calculated as the cost of the drive or softstarter plus a percentage of the life-cycle costs to cover production downtime.

trol for all working points, while for the 350 kW system VFD control guarantees slightly higher energy savings but only between 75 and 92 percent pump ca-

capacity. When a combined hydraulic system ( $v = 25$  percent) is considered, VFD control only ensures a larger economic benefit for pump capacities above 28 percent (for the 90 kW system) and 24 percent (for the 350 kW system). In fact the highest gain with VFD control is found at between 15 and 20 percent capacity.

Unlike frequency converters (characterized by semiconductor losses at nominal load), softstarters operate in bypass state at nominal load → 9c. No additional losses in the thyristors are thus accounted for. The operating and system conditions when either cyclic control or VFD is the preferred solution for pump flow regulation are illustrated in → 10<sup>2</sup>.

### Return on investment

Customers will inevitably want to know when they can expect a return on their investment, which includes the additional costs incurred by production downtime while the drive or softstarter is being installed and commissioned.

For pumps with a power rating of around 25 kW, the price ratio of converter to softstarter is around three and reaches an approximate value of five for 350 kW pumps [6]. The total initial investment associated with VFD and cyclic solutions is calculated as the sum of the cost of the drive or softstarter plus a percentage of the life-cycle costs to cover production downtime [7]. For both power electronic

### Footnote

<sup>2</sup> Converting percentage energy savings (with respect to fixed speed and throttle) into economic benefits assumed that the pump works for 8,760 hours per year (330 x 24) at a price of \$0.065 for 1 kWh of electricity [5].

**9a Energy savings [%] of VFD and cyclic control in the 90 kW pump system**

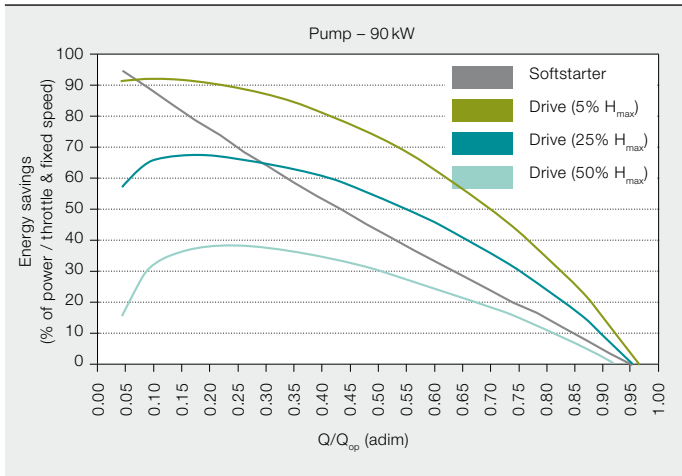

**9b Energy savings [%] of VFD and cyclic control in the 350 kW pump system**

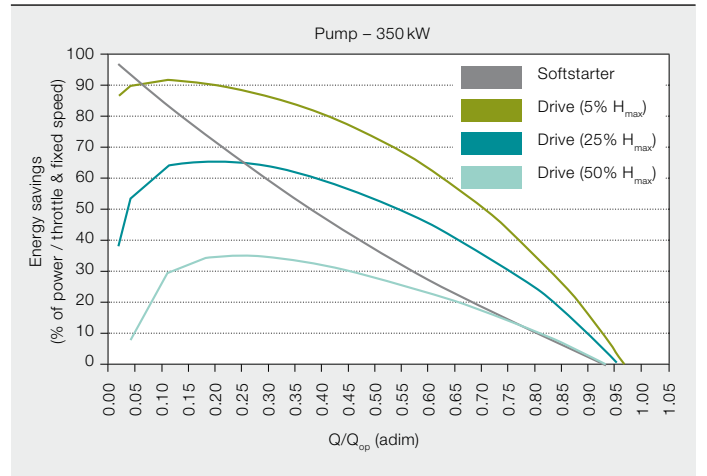

**9c Optimum efficiency in the 90 kW pump due to softstarter bypass capability at high loads (90% - 100% of design capacity)**

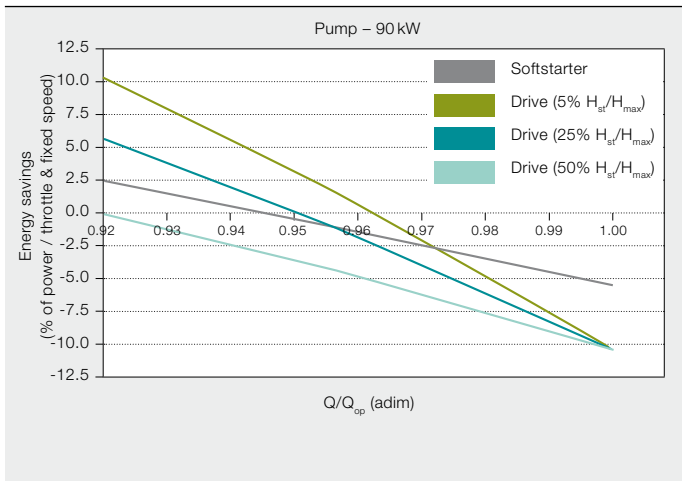

**10 Breakpoint where economic savings with cyclic control (softstarter) become higher than with VFD solution**

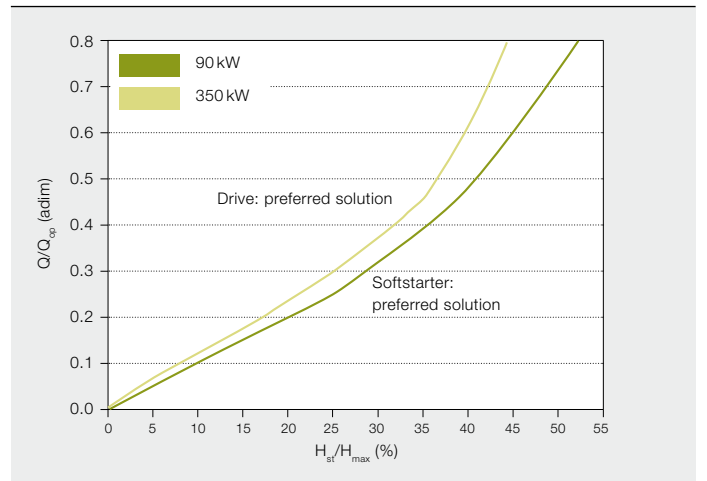

**11a Payback time of VFD and cyclic (soft starter) solutions for the 90 kW pump**

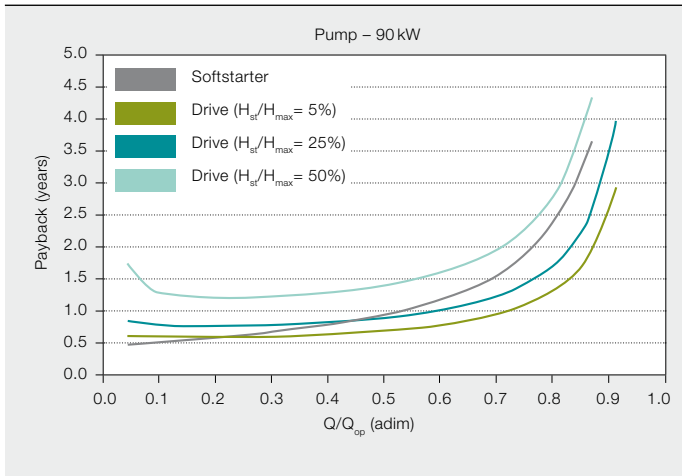

**11b Payback time of VFD and cyclic (soft starter) solutions for the 350 kW pump**

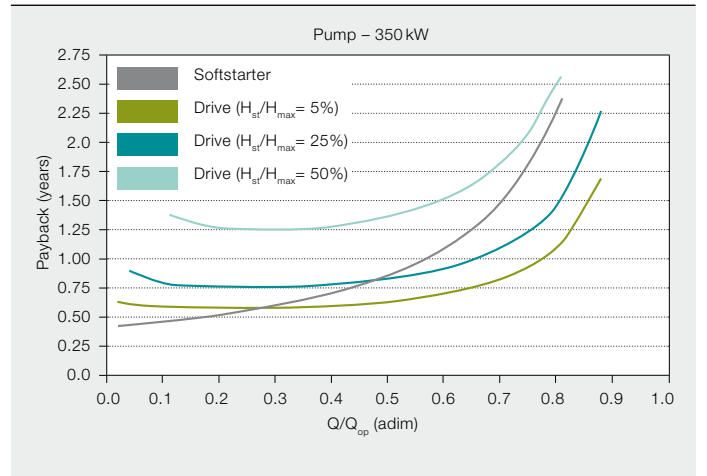

**12 Recommended power electronics solution for a four parallel pump system (friction dominated hydraulic system)**

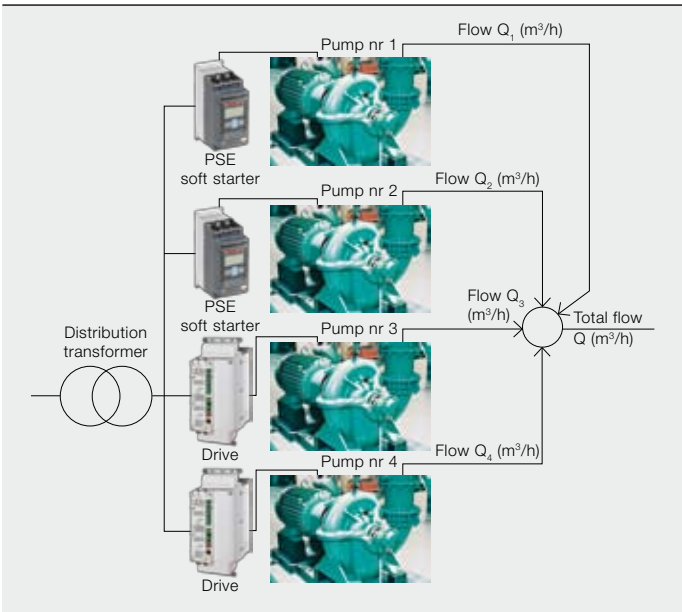

**14 Recommended power electronics solution for a three parallel pump system (Static head/friction dominated hydraulic system)**

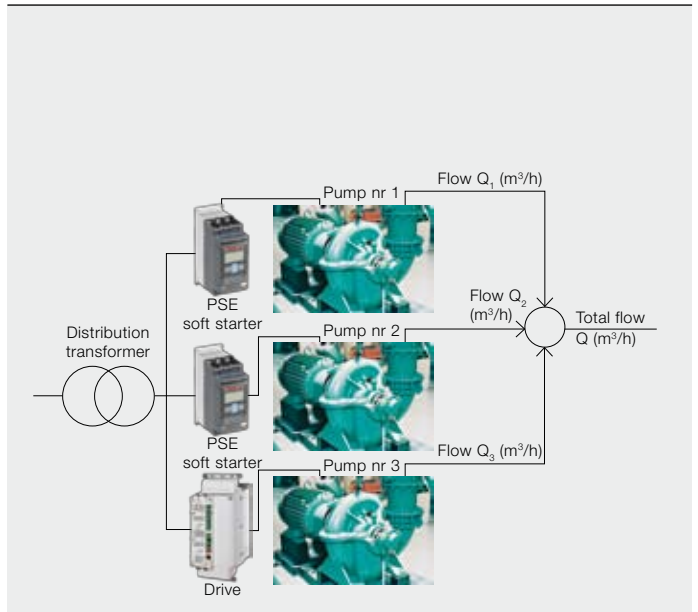

**13 Flow control scheme in a four parallel pump system (friction loss dominated)**

	Pump 1	Pump 2	Pump 3	Pump 4
<b>PE</b>	Softstarter	Softstarter	Drive	Drive
<b>Flow control</b>	Cyclic	Cyclic	VFD	VFD
<b>Flow Q(m³/h)</b>				
0–1,130	On-off (0–22.5%)	On-off (0–22.5%)	Off	Off
1,130–2,500	Off	Off	On (22.5–50% Pn)	On (22.5–50% Pn)
2,500–4,740	On-off (27.5–45%)	On-off (27.5–45%)	On (22.5–50% Pn)	On (22.5–50% Pn)
4,740–5,790	On-off (60%)	On-off (60%)	On (35–85% Pn)	On (35–85% Pn)
5,790–8,000	On-off (75%)	On-off (75%)	On (70–85% Pn)	On (70–85% Pn)
8,000–10,000	By-pass	By-pass	On (60–100% Pn)	On (60–100% Pn)
Higher than 10,000	By-pass	By-pass	On (> 100% Pn)	On (> 100% Pn)

topologies, a value of 7.5 percent is used.

The cost of the individual components may vary for a number of reasons. Primarily, low-voltage VFDs operate more on a continuous rather than a stop-start basis and enable more sophisticated control. However, they use insulated gate bipolar transistors (IGBTs) and must be designed with sufficient cooling capability, making them more expensive when compared to softstarters with the same power rating. Softstarters, on the other hand, which operate during reduced time intervals of up to 15 seconds incorporate robust and cost competitive thyristors and benefit from natural cooling.

The payback times for VFD and cyclic flow control are illustrated in → 11a and → 11b for the 90kW and 350kW

pumps respectively for the three hydraulic systems:  $\nu = 5$  percent, 25 percent and 50 percent.

**Parallel pump system solutions**

In many hydraulic systems, optimum energy savings with a good return on investment can be achieved using parallel pump solutions<sup>3</sup> that combine drives and softstarters.

For example, in a friction dominated hydraulic system ( $\nu = 5$  percent), a recommended power electronics solution for a four parallel pump system – each pump with a power rating of 350kW

(2,500 m³/h) – consists of two converters and two softstarters → 12. The scheme which gives the most optimum solution in terms of payback time and control functionality equips pumps 1 and 2 with a softstarter and pumps 3 and 4 with a frequency converter → 13. Pumps equipped with a softstarter are directly connected to the network at high capacity. By increasing the rotational speed in a pre-defined range (over 50 Hz), pumps driven by converters can deliver a peak flow if occasionally required.

In a mixed hydraulic system ( $\nu = 5$  percent), the scheme which gives the most optimum solution in terms of payback time and control functionality uses three pumps, the first two of which are equipped with softstarters and the third with a drive. → 14 and → 15.

For both systems the initial investment in power electronics solutions is trans-

**Variable-frequency control is the best solution in friction-loss dominated hydraulic systems while cyclic control is recommended for static-head dominated systems.**

lated into economic profit in less than 1.5 years provided the regulated flow

## 15 Flow control scheme in a three parallel pump system (mixed hydraulic system)

	Pump 1	Pump 2	Pump 3
PE	Softstarter	Softstarter	Drive
Flow control	Cyclic	Cyclic	Variable frequency
<b>Flow Q(m<sup>3</sup>/h)</b>			
0–2,500	On-off (0–50%)	On-off (0–50%)	off
2,500–4,500	On-off (30–60%)	On-off (30–60%)	On (40–60% Pn)
4,500–5,760	On-off (60–75%)	On-off (60–75%)	On (60–80% Pn)
5,760–6,630	By-pass	On-off (75%)	On (55–90% Pn)
6,630–7,500	By-pass	By-pass	On (35–100% Pn)
> 7,500	By-pass	By-pass	On (> 100% Pn)

## 16 The estimated payback time for two installations consisting of parallel pumps and different power electronics solutions

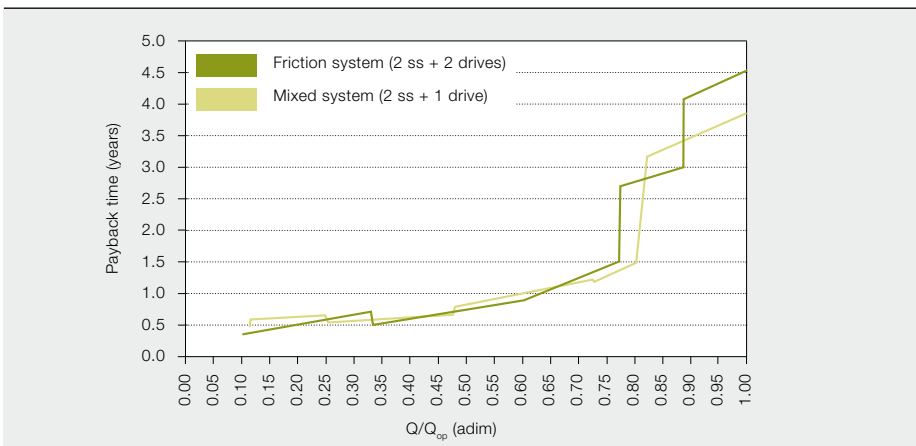

is below 80 percent of the total capacity → 16.

### The best solution?

The suitability of variable-speed and cyclic flow regulation in centrifugal pump applications has been analyzed for two pumps (90 kW and 350 kW) in the low-voltage range. The data show that variable-frequency control is the best solution in friction loss dominated hydraulic systems (fluid transportation without height difference) while cyclic control is recommended for static head dominated systems. Speed control in systems with very flat pump and load characteristics should be avoided due to the risk of instability and pump damage [9].

Softstarters are a very competitive technical solution, especially for water and waste applications in which the regular on/off operation for emptying a tank and pumping up fluid for further treatment is common practice. They are robust, have good bypass capability and dedicated control algorithms for start (kick boost) and stop (no water hammering) sequenc-

es. However, optimum energy savings and good payback times can be achieved in a wide range of hydraulic systems by employing parallel pump schemes that use a combination of drives and softstarters → 17. Supported by their know-how and strong low-voltage automation portfolio, ABB reasserts its commitment to energy efficiency while ensuring customer value.

#### Juan Sagarduy

ABB Corporate Research  
Västerås, Sweden  
juan.sagarduy@se.abb.com

#### Jesper Kristensson

Sören Kling  
Johan Rees  
ABB Cewe Control  
Västerås, Sweden  
jesper.kristensson@se.abb.com  
soren.kling@se.abb.com  
johan.rees@se.abb.com

## 17 Pump system in a water treatment installation



### Footnote

- For optimal flow regulation in parallel systems, one individual pump is operated until a breakpoint in the target flow is reached, after which two pumps simultaneously share the hydraulic load [8]. When a second breakpoint is attained, three pumps become active and so on.

### References

- ITT Industries (2007). ITT's Place in the cycle of water: Everything but the pipes.
- Aurora Pump (Pentair Pump Group) June 1994, United States.
- IEC 60034-31:2009. Rotating electrical machines. Part 31: Guide for the selection and application of energy-efficient motors including variable speed applications.
- Brunner, C. U. (4–5 February 2009). Efficiency classes: Electric motors and systems. Motor energy performance standards event, Sydney (Australia). [www.motorsystems.org](http://www.motorsystems.org).
- Department of Energy (DOE). Energy International Agency (EIA) (June 2009). Average retail price of electricity to ultimate customers.
- Sagarduy, J. (January 2010). Economic evaluation of reduced voltage starting methods. SECRC/PT-RM10/017.
- Hydraulic Institute (August 2008). Pumps & Systems, Understanding pump system fundamentals for energy efficiency. Calculating cost of ownership.
- ITT Flygt (2006). Cirkulationspumpar med våt motor för värmesystem i kommersiella byggnader.
- Voogesang, H. (April 2009). Energy efficiency. Two approaches to capacity control. World Pumps Magazine.